

SILENT

POD



SERENITY IN STYLE



The POD showcases sleek curves and contemporary arches that bring modern sophistication to any work space. It is designed to fit seamlessly yet add an air of calm and serenity to even the busiest of work environments. Minimalist design complement elegant furnishings to create the ultimate workspace that is ergonomic, convenient and conducive. Effective air circulation and comfortable seating allows for uninterrupted work experience. Meanwhile, it's screens provide excellent attention for a perfectly silent and isolated work environment.

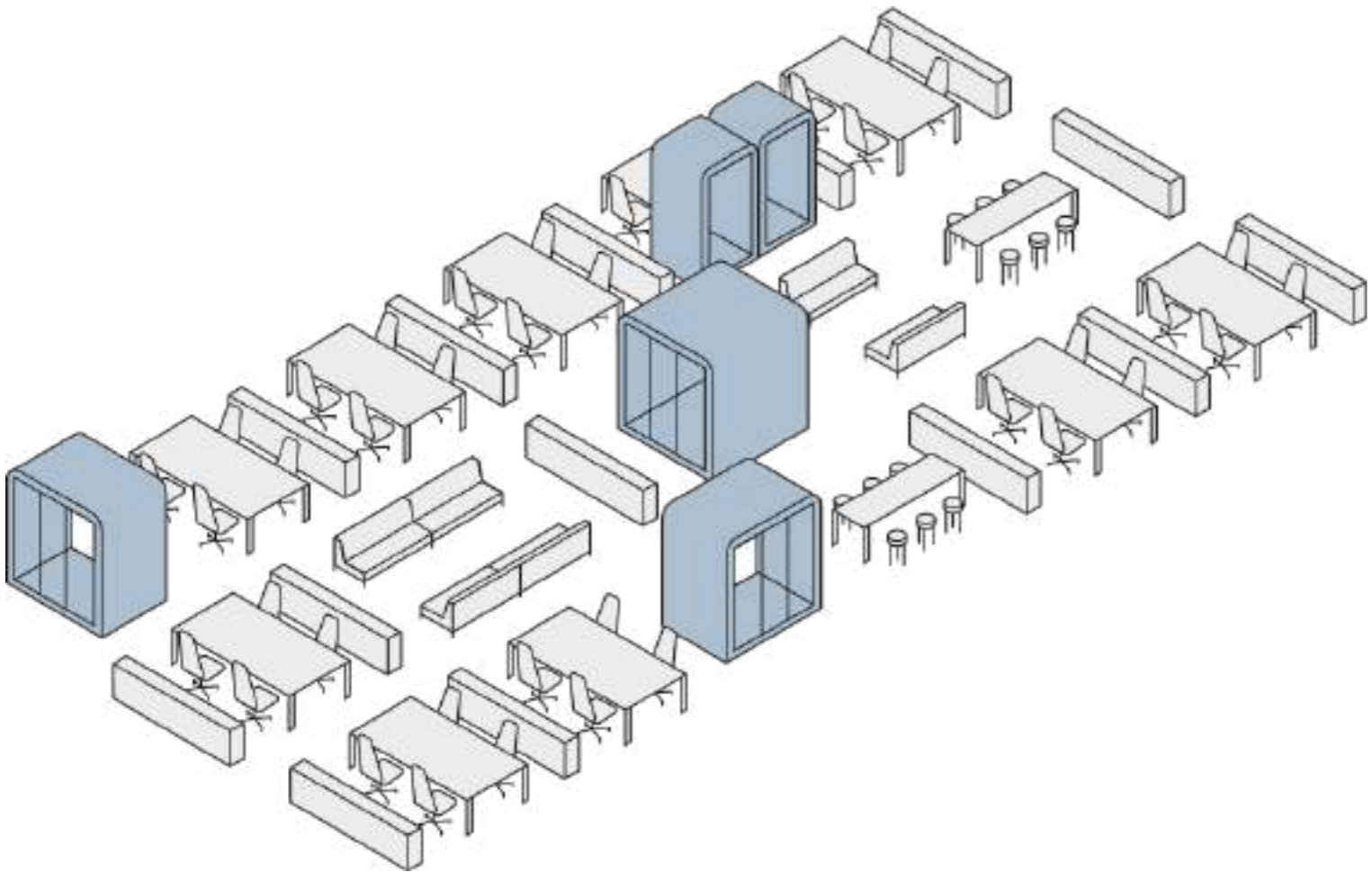

PEACE AND QUIET IN AN INSTANT

The AFC Silent Pod series aims to tackle two primary concerns that arise in open plan workspaces. The first is the necessity for sound insulation, and the second is the need for enclosed rooms inside the workspace. Each Pod is designed to be extremely ergonomic and practical, and includes cutting-edge technology to keep you connected whenever necessary.

PRIVACY

Keep your business YOUR business

Get physical and acoustic privacy away from the chaos of your busy workplace. Whether it's securing that business deal or taking a personal call.

MORE ROOM

One Pod, many uses

While open-plan work environments are great for culture and collaboration, sometimes you just need room away from distractions.

DESIGNED TO FIT

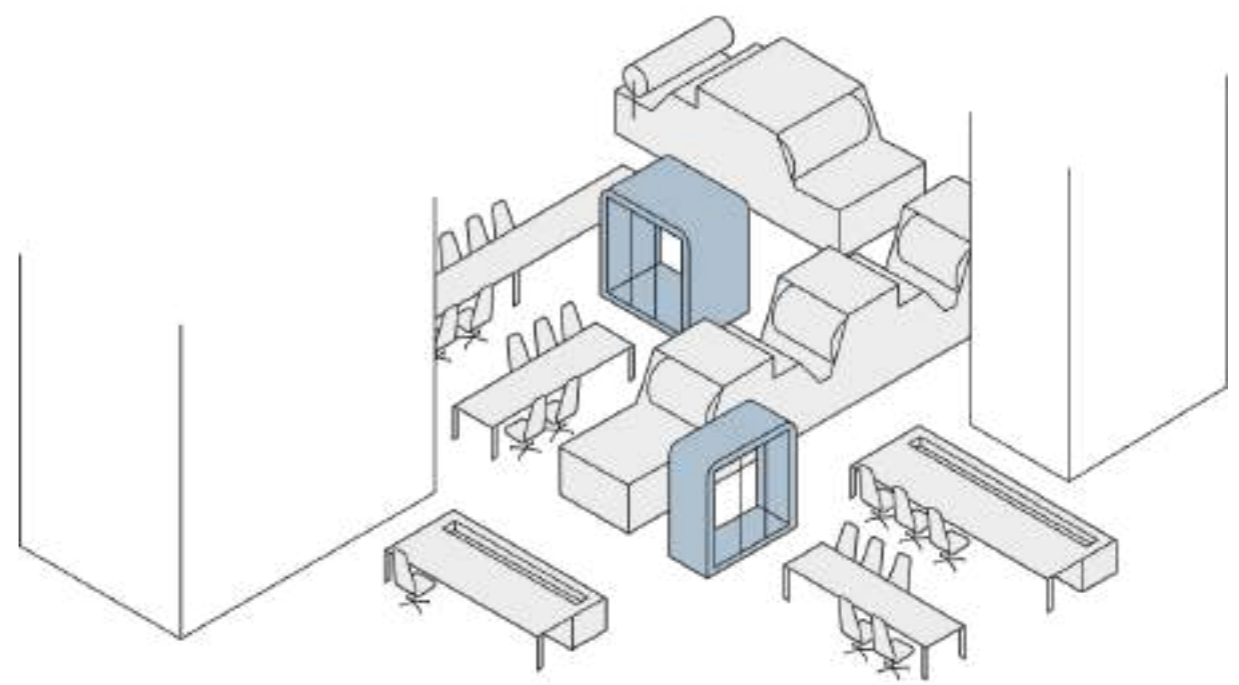



Features

ENERGY EFFICIENT



Sensor based on-off switch activates led lighting and ventilation fan helps to conserve energy.

HIGH ACOUSTIC RATING



Beautifully designed using carefully selected materials with best absorption and isolation performance.

EASY TO ASSEMBLE



Flat packed for ease of delivery and installation.

RETRACTABLE & PORTABLE



Fitted with integrated ball bearings, allowing pods to be easily repositioned into desired locations after assembly.

HIGHEST QUALITY



Sophisticated automation machinery ensures consistency of quality, while robust construction, create products of the finest quality.

COMFORTABLE & BREATHABLE



Work comfortably in a well-ventilated space with great acoustic properties.

Detailed Display



- **Structural Strength Wall Detail:** Electro galvanized 1.2mm thick steel-All metal construction.
- 10mm Double toughened Glass Door
- Power & USB Charging Ports
- **Lighting:** 18w 12Vdc Recessed LED Strip.
- High Acoustic Rating - Beautifully designed and using carefully selected materials with the best absorption and isolation performance. **TUV-32dB/NIC.**
- Fabric Material: Polyester Fiber **Acoustic** Material.
- **Fire Rating:** Acoustic Board, Carpet and Polyester Foam Fire Rated.
- Booth cycle all air in just **2 minutes.**



International
Standard voltage



LED Lighting **4000k** natural
light color temperature



Low noise
exhaust system



Extended wire hole connection
between the cabin and external
equipment



High speed standard sound
insulation **Tuffen glass**

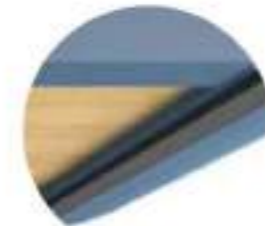

Denim and
sound insulation, control
noise upto 40 decibels

User Experience

AFC silent POD is designed to provide the optimum user experience incorporating these features.

1. Ventilation Fan
2. LED Strip Light
3. Power Supply & USB charging Port
4. Metal + MDF Body
5. Toughened glass & Grade 1 hardware
6. Acoustic Panel
7. Laminated Worktop

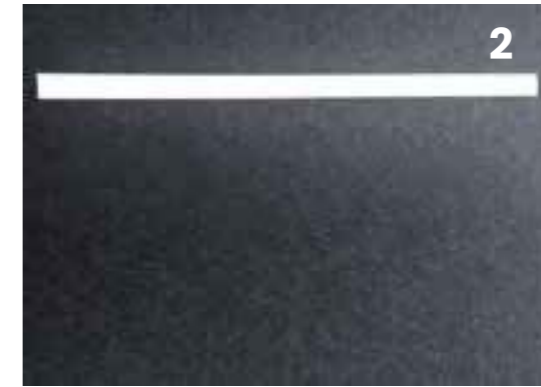
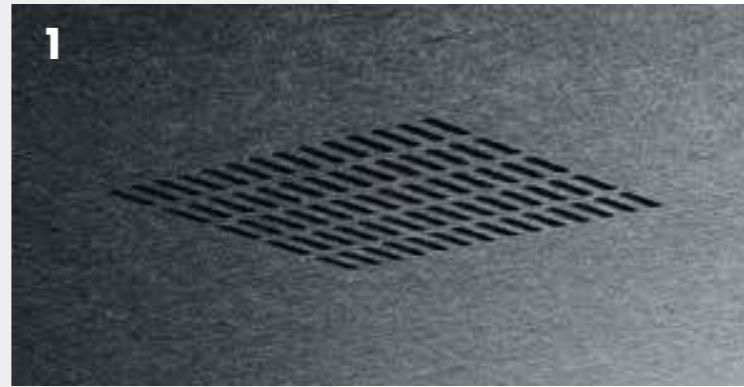

Dimension

Packing Weight - 430kg

Net Weight - 350kg

Internal dimensions - 900 x 950 x 2000h

External dimensions - 1100 x 1100 x 2300h

Area - 1.9m³

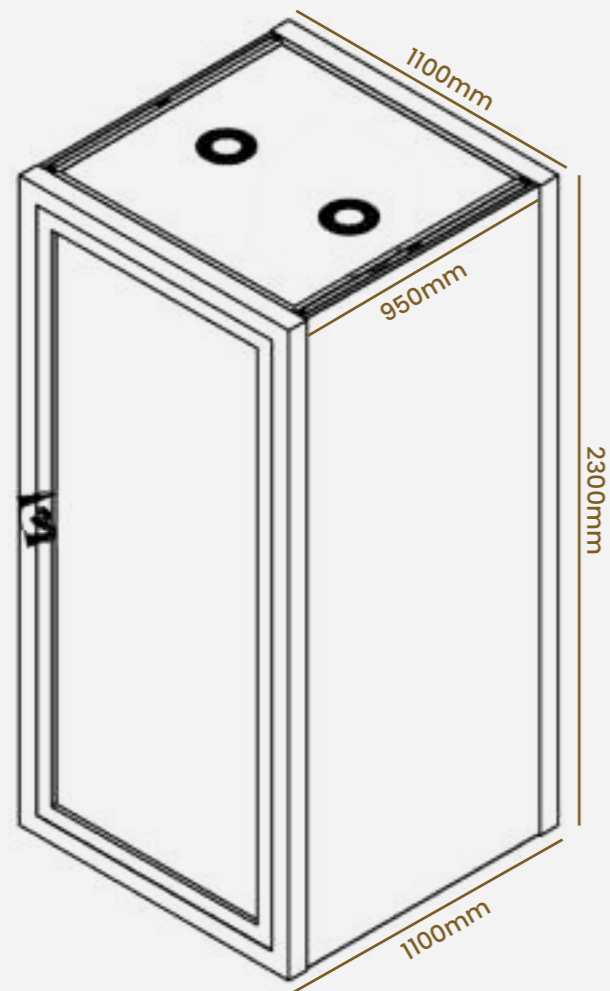

Top View

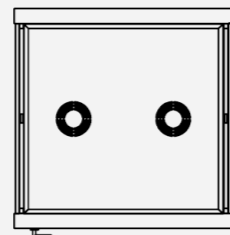

Front View

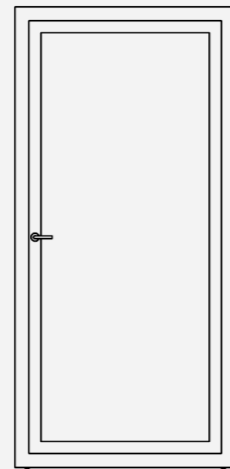

Side View

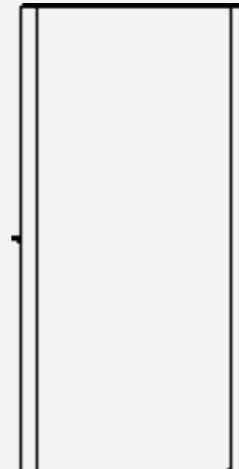

single Pod





Meeting Pod

Packing Weight - 800kg
Net Weight - 650kg
Internal dimensions - 1980 x 950 x 2000h
External dimensions - 2200 x 1200 x 2300h

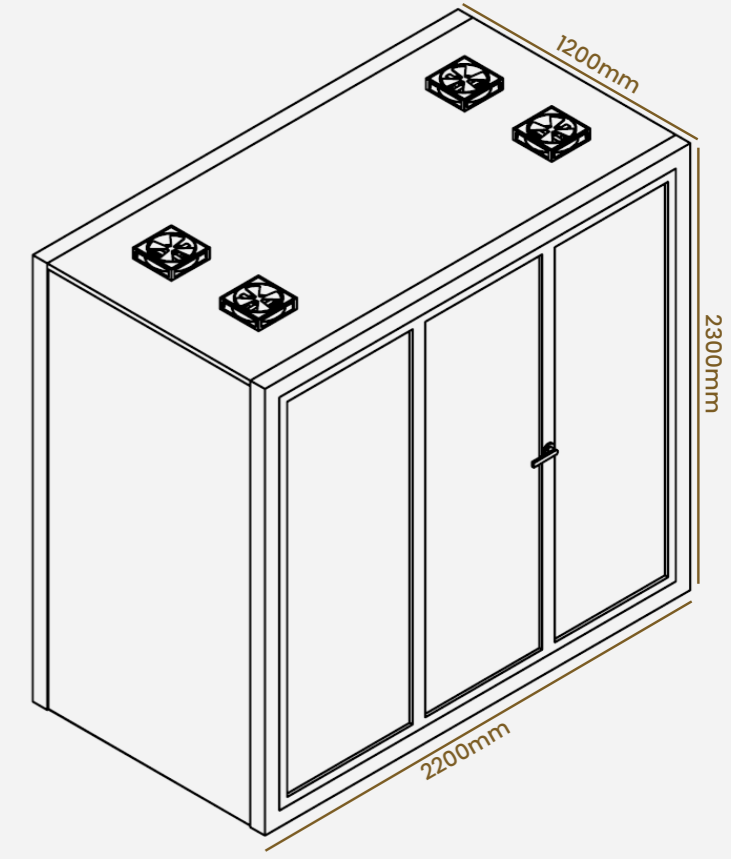

Top View

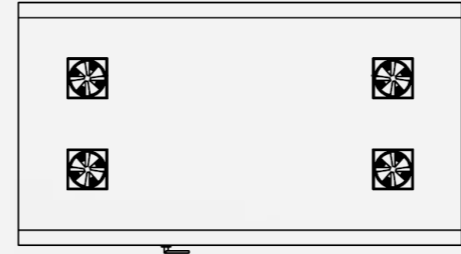

Front View

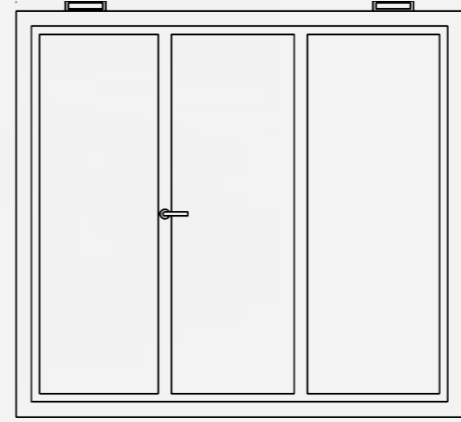

Side View

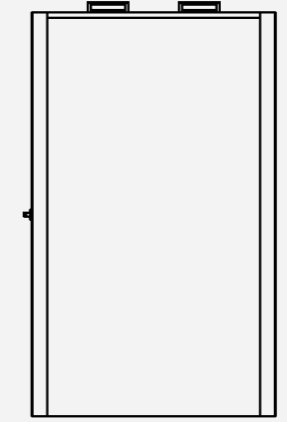



Net Weight - 430kg

Internal dimensions - 1600 x 950 x 2000h

External dimensions - 1800 x 1100 x 2300h

Area - 4.7m³

Work Pod

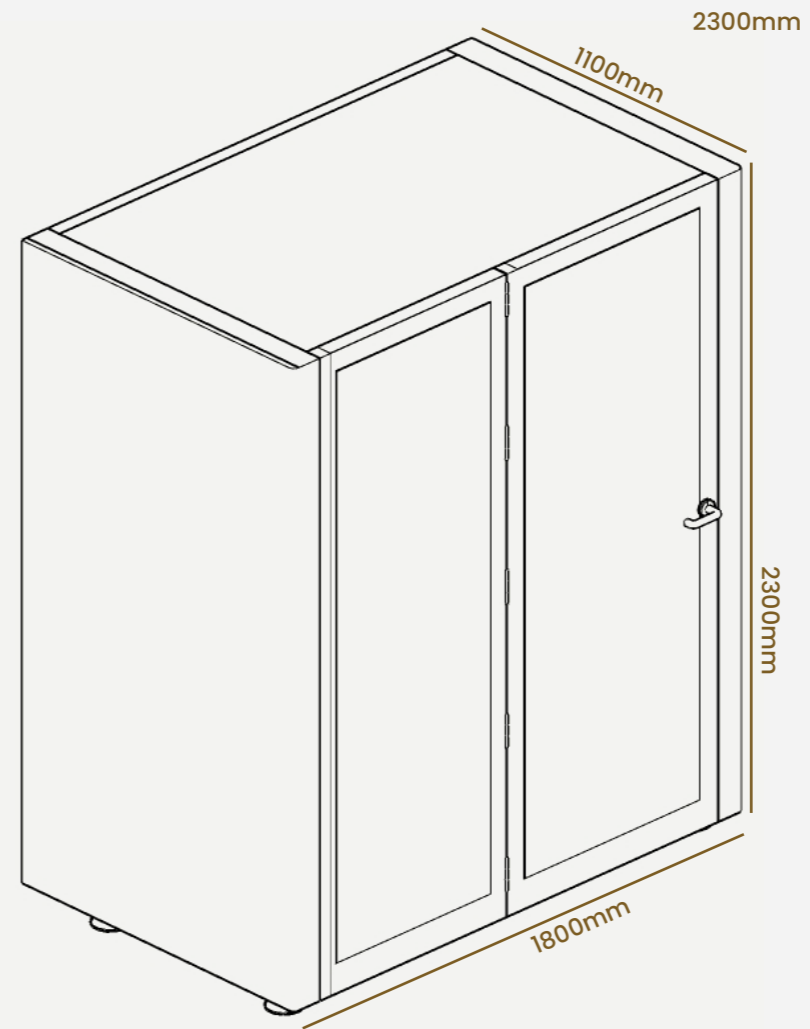

Top View

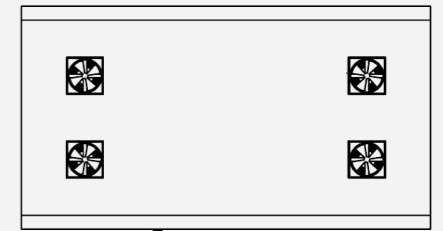

Front View

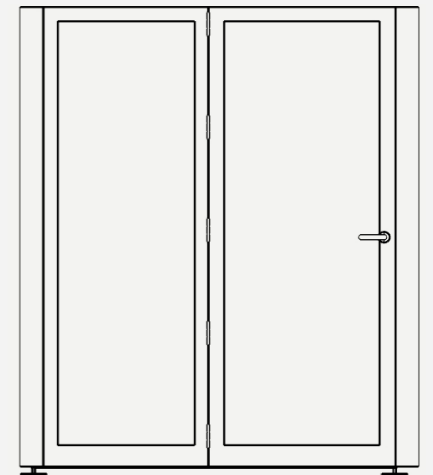

Space designed for
uninterrupted

FOCUS & PRIVACY



Data Sheet

AFC pods come in various sizes and can cater to a range of workspace requirements, such as private phone conversations or group brainstorming sessions. The pods can be customized to include furniture that perfectly fits the space or built according to specific design requirements. They are made to be easy to set up and relocate with minimal effort, thanks to their casters and modular cable system that ensure effortless mobility.

AFC Pods can be customized by:

- Color and finish
- Hardwares
- Inside Furnitures
- Size
- Glaze on one side

Suitable For	1 Person		2-4 Person	
Dimension				
Width x Depth x Height	1100 x 1100 x 2300 mm		2200 x 1200 x 2300 mm	
Furniture				
Desk	Desktop 230 x 460mm		Desk 400 x 600 mm	
Seat	Stool 1		Sofa 2	
Facilities				
Light & Fan control	Inductive		Manual	
Lighting	LED Light (8W/4000K)		LED Light (10W/4000K)	
Ventilation Fan	2		4	
Charging Station	1 Socket, 2 USB ports		2 Sockets, 2 USB ports	
Package				
Quantity	1	1	2	4
Size	2450 x 1200 x 800 mm	2450 x 1200 x 800 mm	2450 x 1200 x 800 mm 2450 x 1200 x 650 mm	2450 x 1200 x 800 mm 2450 x 1200 x 650 mm 1080 x 650 x 700 mm
Net Weight	240 kg	250 kg	370 kg	
Gross Weight	290 kg	300 kg	440 kg	
Assembly				
Person Required	2		4	
Assembly time	0.5 hr		1 hr	

EXTERIOR

Color Selection

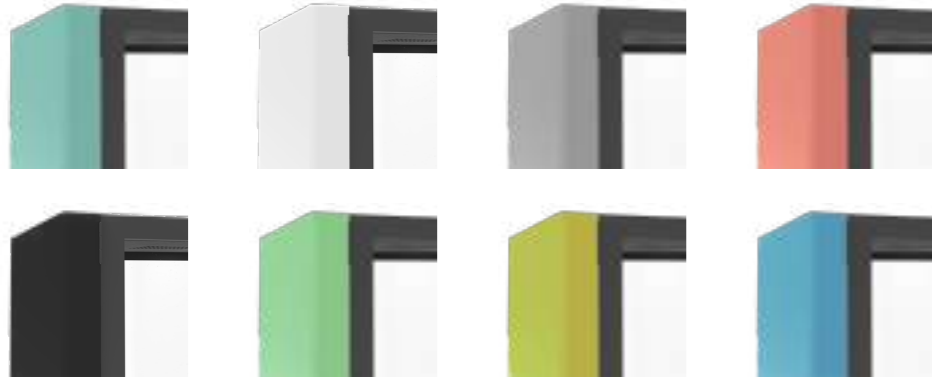

INTERIOR

Acoustic Panel Color Selection

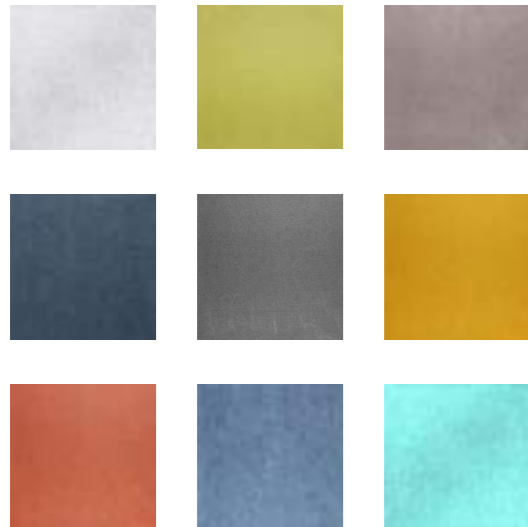

Fabric Color Selection

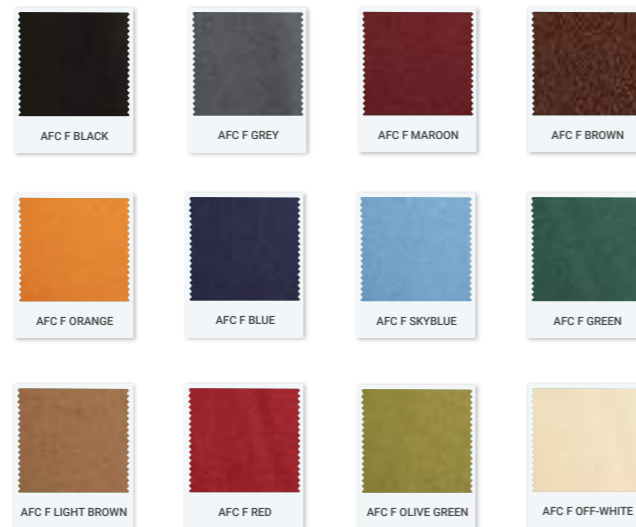



STEP INTO TRANQUILITY

HO - Plot No 33, Ecotech 12, West Greater Noida, UP, 201310

0120-6251848-49, 9999006933

afc@afcindia.in, customer care@afcindia.in

Delhi

Gurgaon

Mumbai

Pune

Bangalore

Hyderabad

Chennai

Kolkata